

Einbauanleitung Installation instructions Instructions de montage Istruzioni per l'instal- lazione Manual de instalación

Leaflet HEMS
1U0022





1KA0022 · Gültig ab: 07.04.26 · QG-00011 – V6.00

Status: Veröffentlicht · Vertraulichkeitsstufe: ÖFFENTLICH · Techn. Dokumentation

Technische Änderungen und Irrtümer vorbehalten, Abbildungen können abweichen.

Technical changes and errors excepted, illustrations may differ.

Sous réserve de modifications techniques et d'erreurs, les illustrations peuvent être différentes.

Salvo modifiche tecniche ed errori, le illustrazioni possono differire.

Quedan reservados cambios en los datos técnicos y errores, las ilustraciones pueden variar.



Android Consolinno App



iOS Consolinno App

Consolinno App
Windows/Linux:

<https://consolinno.de/get-hems-app-windows>



Leaflet
HMS-110022_CO

CONSOLINNO
energy

Consolinno Energy GmbH
Franz-Mayer-Str. 1 10205 Wien Austria
www.consolinno.at



Energy Meter

W3
W4

USB

AC 230V-
50Hz

Die vorliegende Publikation ist urheberrechtlich „geschützt“. Alle Rechte sind vorbehalten. Kein Teil dieser Einbauleitung darf ohne vorherige schriftliche Genehmigung der Consolinno Energy GmbH in irgendeiner Form durch Fotokopie, Mikrofilm oder andere Verfahren reproduziert oder in eine für Maschinen, insbesondere Datenverarbeitungsanlagen, verwendbare Sprache übertragen werden. Auch die Rechte der Wiedergabe durch Vortrag, Funk und Fernsehen sind vorbehalten. Diese Einbauleitung und die dazugehörige Hardware sind urheberrechtlich von der Consolinno Energy GmbH geschützt.

This publication is „protected“ by copyright. All rights are reserved. No part of this installation manual may be reproduced in any form by photocopy, microfilm or other process or translated into a language usable by machines, in particular data processing systems, without the prior written permission of Consolinno Energy GmbH. The rights of reproduction by lecture, radio and television are also reserved. These installation instructions and the associated hardware are protected by copyright of Consolinno Energy GmbH.

La présente publication est „protégée“ par les droits d’auteur. Tous les droits sont réservés. Aucune partie de ces instructions de montage ne peut être reproduite sous quelque forme que ce soit, par photocopie, microfilm ou autre procédé, ou transmise dans un langage utilisable par des machines, notamment des systèmes de traitement de données, sans l’autorisation écrite préalable de Consolinno Energy GmbH. Les droits de reproduction par conférence, radio et télévision sont également réservés. Ces instructions de montage et le matériel correspondant sont protégés par les droits d’auteur de Consolinno Energy GmbH.

Questa pubblicazione è “protetta” da diritto d’autore. Tutti i diritti sono riservati. È vietata la riproduzione di qualsiasi parte delle presenti istruzioni per l’installazione mediante fotocopie, microfilm o altri procedimenti, nonché la trasmissione in un linguaggio utilizzabile da macchine, in particolare da sistemi di elaborazione dati, senza la previa autorizzazione scritta di Consolinno Energy GmbH. Sono riservati anche i diritti di riproduzione tramite conferenze, radio e televisione. Le presenti istruzioni per l’installazione e il relativo hardware sono protetti da diritto d’autore di Consolinno Energy GmbH.

La presente publicación está protegida por derechos de autor. Todos los derechos quedan reservados. Ninguna parte de estas instrucciones de montaje podrá reproducirse sin el consentimiento previo por escrito de Consolinno Energy GmbH en ninguna forma mediante fotocopias, microfiliación u otros procedimientos ni transmitirse a lenguajes empleados por máquinas, especialmente en sistemas de tratamiento de datos. Asimismo, quedan reservados los derechos de la reproducción a través de conferencias, radio y televisión. Tanto este manual de instalación como el software correspondiente están protegidos por derechos de autor a favor de Consolinno Energy GmbH.

6

DEU

16

ENG

26

FRA

36

ITA

46

ESP

Inhalt

Technische Daten	7
Entsorgung	7
Bestimmungsgemäße Verwendung	8
Open Source-Lizenzen	8
Abmessungen	9
Schnittstellen	10
Schnittstellenbeschreibung	11
Taster	11
Sicherheits- und Warnhinweise	12
Installation	12
Inbetriebnahme	14
LEDs	15

Technische Daten

Spannungsversorgung	230 VAC 50 Hz OVCIII
Betriebstemperaturbereich	-5 °C ... 55 °C
Lagerungstemperaturbereich	-5 °C ... 55 °C
Luftfeuchtigkeit	25 % ... 70 % relative Feuchte (nicht kondensierend)
Max. Leistungsaufnahme	3 W
Gewicht	225 g (ohne Gegenstecker)
Brennbarkeitsklasse nach UL94	V0
Maße	4 TE (71,6 mm x 89,7 mm x 69,3 mm)
Verschmutzungsgrad	2
Schutzklasse	II (bei bestimmungsgem. Montage)
Maximale Einsatzhöhe	≤ 3000 m
CE Konformität	Ja

Entsorgung



Das Gerät gilt für die Entsorgung als Elektronik-Altgerät im Sinne der Europäischen Richtlinie 2012/19/EU und darf nicht als Haushaltsmüll entsorgt werden. Senden Sie das Produkt zurück zu Consolinno oder entsorgen Sie das Gerät über die dazu vorgesehenen Wege. Beachten Sie dabei die örtliche und aktuell gültige Gesetzgebung.

Bestimmungsgemäße Verwendung

Dieses Consolinno Produkt darf nur in einem Verteilerschrank oder im Verteilerfeld des Zählerschranks verbaut werden, welche die gängigen Normen und Vorschriften erfüllt. Das Betriebsmittel arbeitet im unbeaufsichtigten Betrieb. Nur geprüfte Komponenten werden an das Betriebsmittel angeschlossen. Die Wartung, Installation und Deinstallation ist nur durch Elektrofachkräfte gestattet. Auf eine sachgemäße Installation muss geachtet werden! Bei unsachgemäßer Umgebung kann es zu Gefährdungen kommen. Das Produkt darf nur nach den Anweisungen der zugehörigen Anleitungen verwendet werden. Aus Sicherheitsgründen dürfen keinerlei Modifikationen am Produkt vorgenommen werden. Eine fachgerechte Entsorgung ist zu gewährleisten.

Open Source-Lizenzen

Das Leaflet beinhaltet unterschiedlich lizenzierte Software, unter anderem GPLv3. Eine detaillierte Auflistung kann über einen Browser im lokalen Netzwerk des Leaflet abgerufen werden. Ein Link dazu befindet sich auch in der App:

`http://{IP-DES-LEAFLET}:8084`

Abmessungen

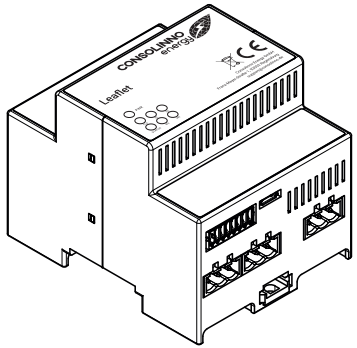
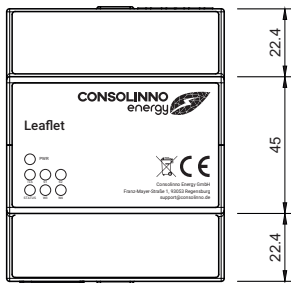
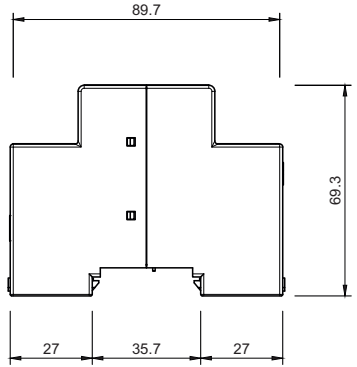
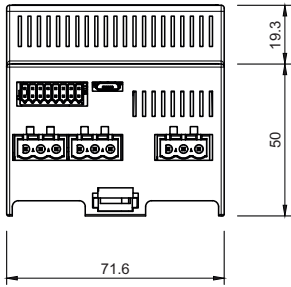

Schnittstellen



Diese Gebrauchsanleitung beschreibt das Consolinno Leaflet HEMS mit allen Funktionen.

Je nach Modul-Variante werden manche hier beschriebenen Funktionen nicht unterstützt.

10



Schnittstellenbeschreibung

Nr.	Beschreibung	Nr.	Beschreibung
1	10/100 Mbit Ethernet	7	Micro-USB 2.0
2	RS-485 / 10/100 Mbit Ethernet	8	Spannungsversorgung 230 VAC 50 Hz
3	Relais 130 mA resistiv (Schließer, LED S1/S2)	9	ZigBee (wireless)
4	Test- / Reset-Taster	10	Bluetooth LE (wireless)
5	Relais 120 mA resistiv (Wechsler, LED W3/W4)	11	Status-LEDs
6	RS-232 / Switches in / RS-485		

Alle Schnittstellen des Consolinno Leaflet HEMS sind galvanisch getrennt.

Taster

Funktion	Beschreibung
Neustart Reset	Reset-Taster für 2 Sek. -> Neustart läuft, STATUS-LED blinkt grün
Factory Reset	Reset-Taster für 10 Sek. -> Factory-Reset läuft, STATUS-LED blinkt rot

Sicherheits- und Warnhinweise



Vor Inbetriebnahme die Einbauanleitung/Gebrauchsanleitung IBA0022 auf service.consolinno.de lesen und das Gerät auf Beschädigungen prüfen!

Sicherheits- und Unfallverhütungsvorschriften sind einzuhalten. Niemals bei anliegender Spannung arbeiten. Das Gerät ist ein Einbaugerät und darf nur in einer montiert werden. Verdrahtung ausreichend dimensionieren und absichern. Das Gerät ist wartungsfrei. Reparaturen sind nur durch den Hersteller durchführbar. Bei Öffnen des Gehäuses erlischt jede Art von Garantie oder Gewährleistung.



GEFAHR

Lebensgefahr durch Stromschlag

Vor Beginn der Arbeiten spannungsfrei schalten! Gegen Wiedereinschalten sichern! Spannungsfreiheit feststellen! Andere spannungsführende Teile abdecken!

Installation

Bei der Installation ist folgendes zu beachten:

- **Das Leaflet HEMS darf nur in einem Verteilerschrank oder im Verteilerfeld des Zählerschranks verbaut werden**
- **Für die vorschriftsgemäße Verwendung des Leaflet HEMS wird eine Trennvorrichtung für die Stromversorgung benötigt**
- Die Trennvorrichtung muss geeignet angeordnet und leicht zugänglich sein
- Sie muss mindestens eine Phase der Versorgung schaltbar machen und als für das Leaflet HEMS gekennzeichnet sein

HINWEIS**BESCHÄDIGUNG ODER FEHLFUNKTION
DURCH FALSCHES SPANNUNGSVERSORGUNG**

Das Gerät kann durch Betrieb mit einer falschen Versorgungsspannung beschädigt werden oder nicht ordnungsgemäß funktionieren.



Das Gerät darf nur mit der vorgeschriebenen Spannung von 230 V +- 10% betrieben werden!

Zur Spannungsversorgung muss Phase L sowie Neutraleiter N verbunden werden.



Beigelegten Aufkleber mit Seriennummer/MAC-Adresse in der verkleben, weiteren Aufkleber gut verwahren!

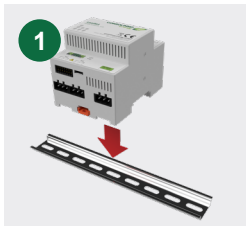

Leaflet HEMS auf die Hut-schiene stecken. Mit Hilfe von Federhaken rastet dieses von selbst ein.

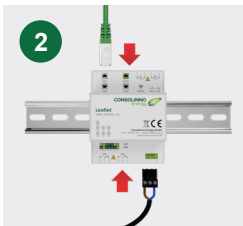

Netzwerk mit Internet (LAN1), Spannungsversorgung und benötigte Stecker verkabeln, auf Sicherheit überprüfen und Spannungsversorgung herstellen.

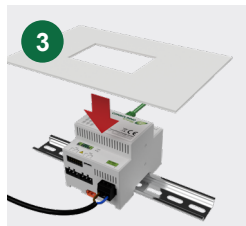















Nach der Inbetriebnahme per App das HEMS mittels Abdeckung gegen Berührung im Verteilerschrank sichern.

Inbetriebnahme

Nr.	Funktion	Beschreibung
1	App installieren	Consolinno Energy App aus Play-/App-Store installieren
2	Internetverbindung herstellen	Leaflet HEMS an LAN1 mit dem Heimnetzwerk (Internet) verbinden. Der Verbindungsstatus wird über die TLS-LED angezeigt
3	Mit Heimnetzwerk verbinden	Smartphone mit Heimnetzwerk verbinden
4	Verbindung mit Leaflet aufbauen	App starten, Leaflet auswählen aus der Liste oder „Manuelle Verbindung“ wählen und Verbindungsdaten eingeben (Port=2222)
5	Login	Accountname und Passwort vergeben
6	Einrichtung starten	Einrichtung mit dem Assistenten starten
7	Endkunden-account anlegen	Nach der Inbetriebnahme den Account für Kunden anlegen (über Systemeinstellungen -> Benutzereinstellungen)
8	Fernverbindung aktivieren	Fernverbindung aktivieren unter Systemeinstellungen -> Verbindungseinstellungen (ermöglicht Zugriff auf das Leaflet aus der Ferne)

Ausführliche Informationen zur Konfiguration und Bedienung der HEMS-Software in der Gebrauchsanleitung IBA0022.

LEDs

	LED	Zustand	Beschreibung
Power LED		Dauerhaft	Aktiv
		Aus	Aus
TLS (Kommunikation)		Dauerhaft	Netzwerkverbindung aktiv
		Aus	Keine Netzwerkverbindung
STATUS LED		Dauerhaft	System läuft einwandfrei
Authentifizierung / Registrierung		Blinkt langsam	Registrierung möglich
		Dauerhaft	Registrierung startet
		3x schnell blinkend, dann grün	Registrierung erfolgreich
		3x schnell blinkend, dann grün	Registrierung fehlerhaft
Update		2x schnell blinkend	Aktualisierung verfügbar
		3x schnell blinkend	Akt. wird heruntergeladen
		4x schnell blinkend	Akt. wird durchgeführt
Servicestatus		2x schnell blinkend	Softwarefehler
		3x schnell blinkend	Fehler Optimierer
		4x schnell blinkend	Fehler OTA
S1/S2; W1/W2		Dauerhaft	Relais aktiv (geschlossen)

Content

Technical Data	17
Disposal	17
Intended use	18
Open Source-Licenses	18
Dimensions	19
Interfaces	20
Interface description	21
Pushbuttons	21
Safety and warning instructions	22
Installation	22
Activation	24
LEDs	25

Technical Data

Power supply	230 VAC 50 Hz OVCIII
Operating temperature range	-5 °C ... 55 °C
Storage temperature range	-5 °C ... 55 °C
Humidity	25 % ... 70 % relative humidity, (non-condensing)
Max. power consumption	3 W
Weight	225 g (without mating connector)
Flammability class acc. to UL94	V0
Dimensions	4 TE (71.6 mm x 89.7 mm x 69.3 mm)
Pollution degree	2
Protection class	II (when mounted as intended)
Maximum operating altitude	≤ 3000 m
CE conformity	Yes

Disposal



The device is considered for disposal as waste electronic equipment according to the European Directive 2012/19/EU and must not be disposed of as household waste. Return the product to Consolinno or dispose of the device via the channels provided for this purpose. Observe the local and currently valid legislation.

Intended use

This Consolinno product may only be installed in a distribution cabinet or in the distribution field of the meter cabinet which complies with the current standards and regulations. The equipment operates in unattended mode. Only tested and approved components are connected to the equipment.

Maintenance, installation and deinstallation may only be carried out by qualified electricians. Care must be taken to ensure proper installation! In case of improper installation, hazards may occur. The product may only be used in accordance with the relevant instructions manuals. For safety reasons, no modifications of any kind may be made to the product. Proper disposal must be ensured.

Open Source-Licenses

The leaflet contains variously licensed software, including GPLv3. A detailed listing can be accessed via a browser on the local network. A link to this is also provided in the app:

<http://{IP-OF-LEAFLET}:8084>

Dimensions

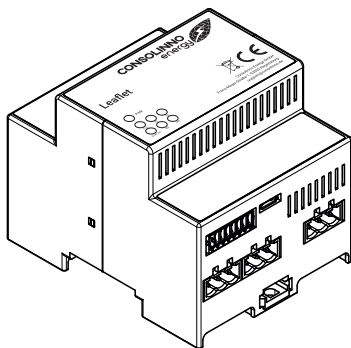
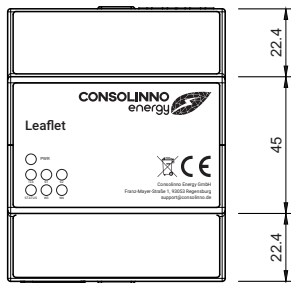
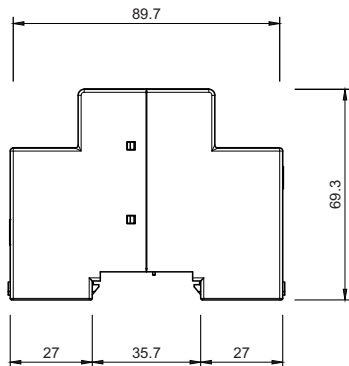
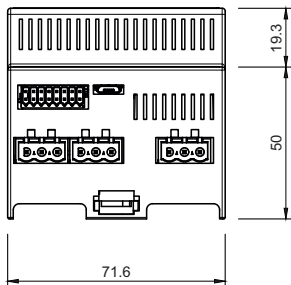

Interfaces



These operating instructions describe the Consolinno Leaflet HEMS with all its functions.

Depending on the module variant, some functions described here are not supported.

20

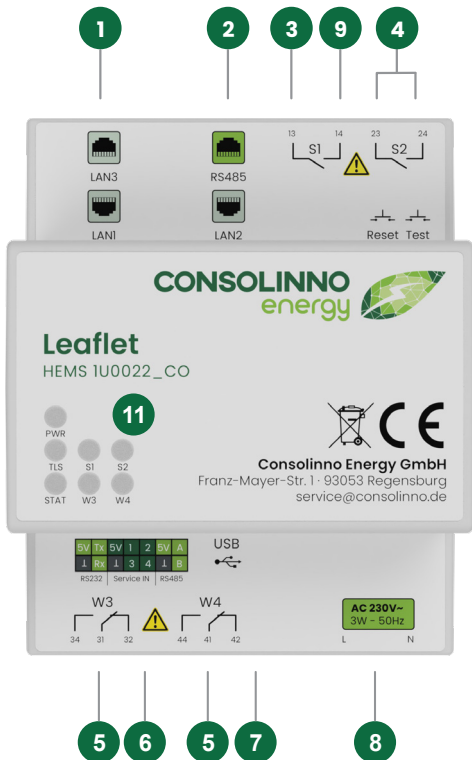

Interface description

No.	Description	No.	Description
1	10/100 Mbit Ethernet	7	Micro-USB 2.0
2	RS-485 / 10/100 Mbit Ethernet	8	Power supply 230 VAC 50 Hz
3	Relais 130 mA resistive (normally open, LED S1/S2)	9	ZigBee (wireless)
4	Test / Reset button	10	Bluetooth LE (wireless)
5	Relais 120 mA resistive (change-over contact, LED W3/W4)	11	Status-LEDs
6	RS-232 / Switches in / RS-485		

All interfaces of the Consolinno Leaflet HEMS are galvanically isolated!

Pushbuttons

Function	Description
Restart Reset	Reset button for 2 sec. -> restart runs, STATUS-LED flashes green
Factory Reset	Reset button for 10 sec. -> reset runs, STATUS-LED flashes red

Safety and warning instructions



Before commissioning, read the installation instructions/ user manual IBA0022 at service.consolinno.de and check the device for damage!

Safety regulations must be observed. Never work when voltage is applied. The device is a built-in device and may only be installed in a subdistribution cabinet. Wiring must be adequately dimensioned and fused. The device is maintenance-free. Repairs are only be carried out by the manufacturer. Opening the housing voids the warranty.



DANGER

Danger to life due to electric shock

Disconnect the power supply before starting work! Secure against being switched on again! Check that no voltage is present! Cover other live parts!

Installation

NOTE

The Leaflet HEMS may only be installed in a distribution cabinet or in the distribution field of the meter cabinet. To use the Consolinno Leaflet in accordance with the regulations, a disconnecting device for the power supply is required. This must be suitably located and easily accessible. It must make at least one phase of the supply switchable and be marked as being for the Leaflet.

NOTE

The device function is guaranteed without restriction in the range of 230V $\pm 10\%$ of the voltage supply! Phase

L as well as neutral conductor N must be connected to the power supply.



Attach the enclosed sticker with serial number/MAC address in the subdistribution cabinet, keep other stickers in a safe place!

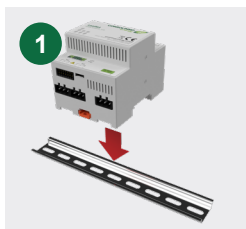

Attach the Leaflet HEMS onto the DIN rail. With the help of spring hooks it will snap in by itself.

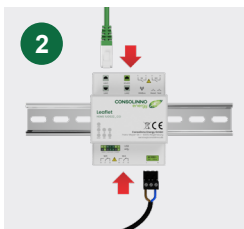

Connect the network with Internet (LAN), power supply and required plugs, check for safety and establish power supply.

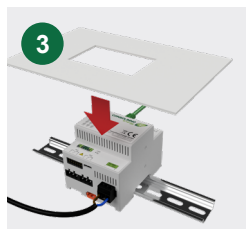















After activation via app, secure the cover of the HEMS module to prevent accidental contact.

Activation

No.	Function	Description
1	Install app	Install Consolinno Energy app from play/app store
2	Establish internet connection	Connect Leaflet LAN1 to the home network (internet). The connection status is indicated by the TLS LED
3	Connect to home network	Connect smartphone to home network
4	Establish connection with Leaflet	Launch app, select Leaflet from the list or select „Manual connection“ and enter connection data (port =2222)
5	Login	Assign login account name and password
6	Start setup	Start setup with the wizard
7	Create end customer account	After startup, create the account for customers (via System settings -> User settings)
8	Activate remote connection	Activate under System settings -> Connection settings (allows access to the leaflet remotely)

For detailed information on configuring and operating the HEMS software, refer to the IBA0022 user manual.

LEDs

	LED	Zustand	Description
Power LED		permanently	active
		off	off
TLS (communication)		permanently	network connection active
		off	no network connection
STATUS LED		permanently	system is running
Authentication / Registration		flashes slowly	registration possible
		permanently	registration ist starting
		3x quick flashes, then green	registration successful
		3x quick flashes, then green	registration error
Update		2x quick flashes	update available
		3x quick flashes	update download
		4x quick flashes	upd. is being performed
Service status		2x quick flashes	software error
		3x quick flashes	optimizer error
		4x quick flashes	OTA error
S1/S2; W1/W2		permanently	relais active (closed)

Contenu

Caractéristiques techniques	27
Élimination	27
Utilisation conforme	28
Licences open source	28
Dimensions	29
Interfaces	30
Description de l'interface	31
Bouton-poussoir	31
Consignes de sécurité et avertissements	32
Installation	32
Mise en service	34
LEDs	35

Caractéristiques techniques

Alimentation électrique	230 VAC 50 Hz OVCIII
Plage de température de fonctionnement	-5 °C ... 55 °C
Plage de température de stockage	-5 °C ... 55 °C
Humidité de l'air	25 % ... 70 % d'humidité relative (sans condensation)
Puissance max. absorbée	3 W
Poids	225 g (sans contre-connecteur)
Classe d'inflammabilité selon UL94	V0
Dimensions	4 TE (71,6 mm x 89,7 mm x 69,3 mm)
Degré de pollution	2
Classe de protection	II (en cas de montage conforme)
Altitude maximale d'utilisation	≤ 3000 m
Conformité CE	Oui

Élimination



L'appareil est considéré pour l'élimination comme un appareil électronique usagé au sens de la directive européenne 2012/19/UE et ne doit pas être éliminé avec les déchets ménagers. Renvoyez le produit à Consolinno ou éliminez

l'appareil par les voies prévues à cet effet. Respectez la législation locale et en vigueur.

Utilisation conforme

Ce produit Consolinno ne peut être monté que dans un tableau de distribution ou dans le champ de distribution du tableau de comptage secondaire qui répond aux normes et prescriptions courantes. Le matériel électrique fonctionne sans surveillance. Seuls des composants contrôlés sont raccordés au matériel électrique. L'entretien, l'installation et la désinstallation ne peuvent être effectués que par des électriciens spécialisés. Il faut veiller à une installation correcte ! Un environnement non conforme peut entraîner des risques. Le produit ne doit être utilisé que conformément aux instructions des manuels correspondants. Pour des raisons de sécurité, aucune modification ne doit être apportée au produit. Une élimination appropriée doit être effectuée.

Licences open source

Le leaflet contient différents logiciels sous licence, dont la GPLv3. Une liste détaillée peut être consultée via un navigateur sur le réseau local du Leaflet. Un lien vers cette liste se trouve également dans l'application:

<http://{IP-DE-LEAFLET}:8084>

Dimensions

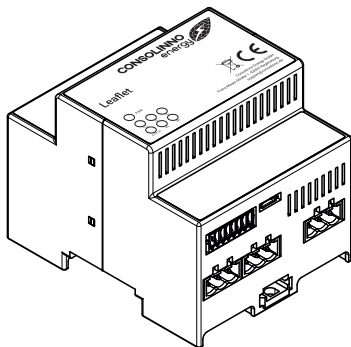
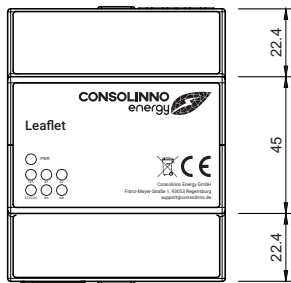
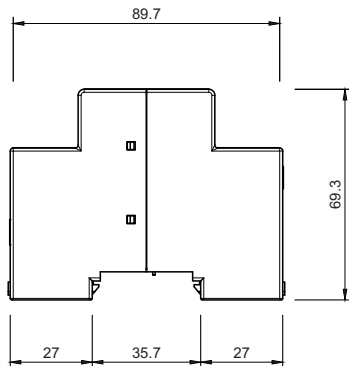
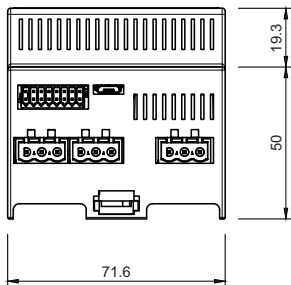

Interfaces



Ce mode d'emploi décrit le Leaflet HEMS de Consolinno avec toutes ses fonctions. Selon la variante de module, certaines fonctions décrites ici ne sont pas supportées.

30

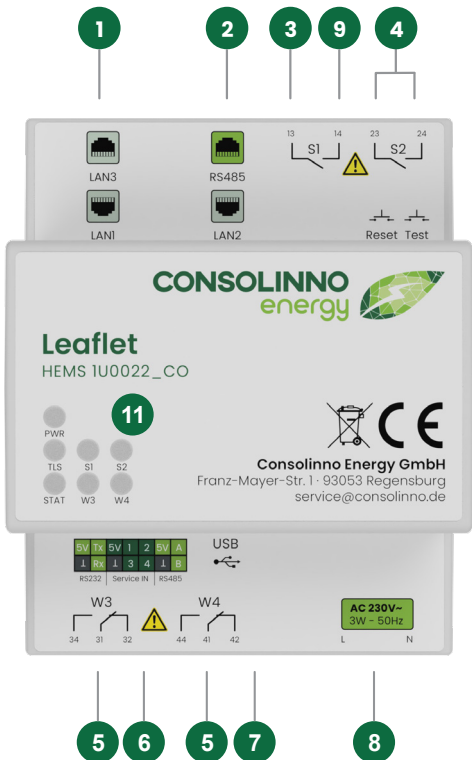

Description de l'interface

No.	Description	No.	Description
1	10/100 Mbit Ethernet	7	Micro-USB 2.0
2	RS-485 / 10/100 Mbit Ethernet	8	Alimentation électrique 230 VAC 50 Hz
3	Relais 130 mA résistif (contact à fermeture, LED S1/S2)	9	ZigBee (sans fil)
4	Bouton test/réinitialisation (sans fil)	10	Bluetooth LE (sans fil)
5	Relais 120 mA résistif (contact inverseur, LED W3/W4)	11	LED status
6	RS-232 / Commutateurs in / RS-485		

Toutes les interfaces du Leaflet HEMS de Consolinno sont isolées galvaniquement !

Bouton-poussoir

Fonction	Description
Redémarrage Réinitialisation	Bouton de réinitialisation pendant 2 sec -> le redémarrage est en cours, la LED STATUS clignote en vert
Réinitialisation d'usine	Bouton de réinitialisation pendant 10 sec -> la réinitialisation est en cours la LED STATUS clignote en rouge

Consignes de sécurité et avertissements



Avant la mise en service, lire la notice de montage/d'utilisation 1BA0022 sur service.consolinno.de et vérifier que l'appareil n'est pas endommagé !

Les consignes de sécurité et de prévention des accidents doivent être respectées. Ne jamais travailler lorsque l'appareil est sous tension. L'appareil est un appareil encastrable et ne doit être monté que dans un tableau de distribution secondaire. Dimensionner et sécuriser suffisamment le câblage. L'appareil ne nécessite aucun entretien. Les réparations ne peuvent être effectuées que par le fabricant. L'ouverture du boîtier annule la garantie.



DANGER

Danger de mort par électrocution

Mettre hors tension avant de commencer les travaux! Protéger contre toute remise en marche! Vérifier l'absence de tension! Recouvrir les autres pièces sous tension !

Installation

REMARQUE

Le Leaflet HEMS ne peut être installé que dans un tableau de distribution ou dans le champ de distribution du tableau de comptage. Pour une utilisation conforme du Leaflet de Consolinno, un dispositif de séparation de l'alimentation électrique est nécessaire. Celui-ci doit être disposé de manière appropriée et être facilement accessible. Il doit rendre commutable au moins une phase de l'alimentation et être identifié comme étant destiné au Leaflet.

REMARQUE

Le fonctionnement de l'appareil est garanti sans restriction dans une plage de $230V \pm 10\%$ de la tension d'alimentation ! Pour l'alimentation en tension, la phase L ainsi que le conducteur neutre N doivent être reliés.



Coller l'autocollant joint avec le numéro de série/l'adresse MAC dans la distribution secondaire, bien conserver les autres autocollants !

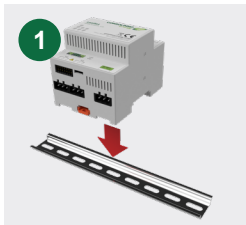

Insérez le Leaflet HEMS sur le profilé chapeau. À l'aide de crochets à ressort, celui-ci s'enclenche de lui-même.

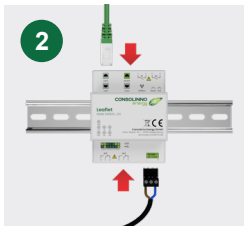

Câblez le réseau avec Internet (LAN1), l'alimentation en tension et les connecteurs nécessaires, vérifiez la sécurité et établissez l'alimentation en tension.

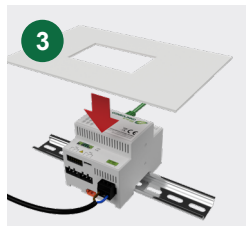











Après la mise en service via l'application, protéger l'HEMS contre tout contact dans le tableau de distribution au moyen d'un couvercle.

Mise en service

Nr.	Fonction	Beschreibung
1	Installation de l'application	Installer l'application Consolinno Energy sur Play-/App-Store
2	Établir une connexion Internet	Connecter Leaflet LANI au réseau domestique (Internet). L'état de la connexion est indiqué par la LED TLS
3	Connecter au réseau domestique	Connecter le smartphone au réseau domestique
4	Établir une connexion avec Leaflet	Lancer l'app, sélectionner Leaflet dans la liste ou choisir "Connexion manuelle" et entrer les données de connexion (port = 2222)
5	Login	Attribuer un nom de compte et un mot de passe
6	Démarrer la configuration	Démarrer la configuration avec l'assistant
7	Créer un compte pour les clients finaux	Après la mise en service, créer le compte pour les clients (via Paramètres système -> Paramètres utilisateur)
8	Activer la connexion à distance	Activer sous Réglages système -> Réglages de connexion (permet d'accéder à distance au leaflet)

Informations détaillées sur la configuration et l'utilisation du logiciel HEMS dans le mode d'emploi IBA0022.

LEDs

	LED	Zustand	Description	
Power LED		permanent	actif	
		désactivé	désactivé	
TLS (communication)		permanent	connexion réseau active	
		désactivé	aucune connexion internet	
STATUS LED		permanent	système actif	
Authentification / Registration		clignote lentement	inscription possible	
		permanent	inscriptions commencent	
		clignote 3x vite, puis verte	Inscription réussie	
Mise à jour		clignote 3x vite, puis verte	inscription échoué	
			clignote 2x vite	mise à jour disponible
			clignote 3x vite	mise à jour téléchargement
			clignote 4x vite	m.à.j. en cours d'installation
État du service		clignote 2x vite	erreur logicielle	
		clignote 3x vite	optimiseur d'erreurs	
		clignote 4x vite	OTA d'erreurs	
S1/S2; W1/W2		permanent	Relais active (fermé)	

Contenuti

Dati tecnici	37
Smaltimento	37
Uso previsto	38
Licenze Open Source	38
Dimensioni	39
Interfacce	40
Descrizione dell'interfaccia	41
Pulsante	41
Istruzioni di sicurezza e avvertenze	42
Installation	42
Messa in funzione	44
LED	45

Dati tecnici

Alimentazione	230 VAC 50 Hz OVCIII
Temperatura di funzionamento	-5 °C ... 55 °C
Temperatura di stoccaggio	-5 °C ... 55 °C
Umidità	25 % ... 70 % di umidità relativa (senza condensa)
Consumo max. di energia	3 W
Peso	225 g (senza adattatore)
Classe di infiammabilità secondo UL94	V0
Dimensioni	4 TE (71,6 mm x 89,7 mm x 69,3 mm)
Grado di inquinamento	2
Classe di protezione	II (se montato correttamente)
Altezza massima di funzionamento	≤ 3000 m
Conformità CE	Sì

Smaltimento



Il prodotto è considerato un'apparecchiatura elettronica di scarto ai sensi della Direttiva Europea 2012/19/UE e non deve essere smaltito come rifiuto domestico. Restituire il prodotto a Consolingo o smaltire il prodotto tramite i canali previsti.

Rispettare la legislazione locale e quella attualmente in vigore.

Uso previsto

Questo prodotto Consolinno può essere montato solo in un quadro di distribuzione o nel campo di distribuzione del quadro del contactore, conforme alle norme e ai regolamenti vigenti. L'apparecchiatura funziona in modalità non presidiata. Sull'apparecchiatura sono collegati solo componenti testati. La manutenzione, l'installazione e la disinstallazione possono essere eseguite solo da elettricisti qualificati. È necessario assicurarsi che l'installazione venga effettuata in modo corretto! Un ambiente inadeguato può generare pericoli. Il prodotto può essere utilizzato solo in conformità alle istruzioni contenute nella documentazione allegata. Non è consentito apportare modifiche di alcun tipo al prodotto per motivi di sicurezza. È necessario garantire un corretto smaltimento.

Licenze Open Source

Il Leaflet contiene software con varie licenze, tra cui la GPLv3. Un elenco dettagliato può essere consultato tramite un browser nella rete locale del Leaflet. Un link è disponibile anche all'interno dell'app:

<http://{IP-DEL-LEAFLET}:8084>

Dimensioni

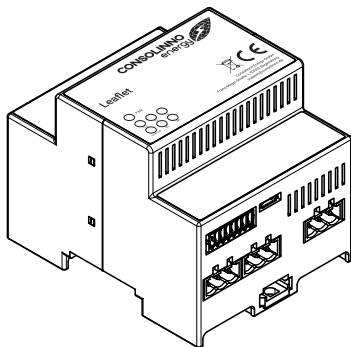
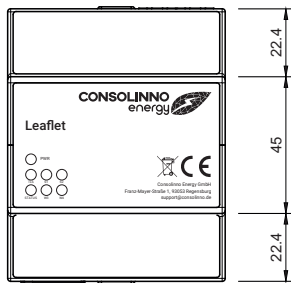
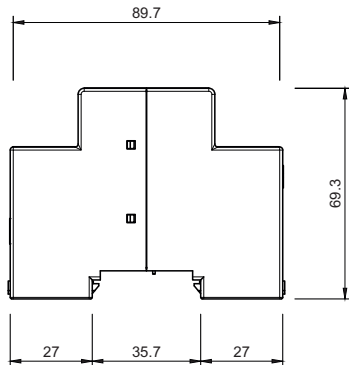
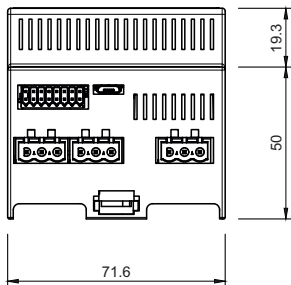

Interfacce



Queste istruzioni per l'uso descrivono il Leaflet HEMS di Consolinno con tutte le sue funzioni. In base alla variante del modulo, alcune funzioni non sono supportate.

40

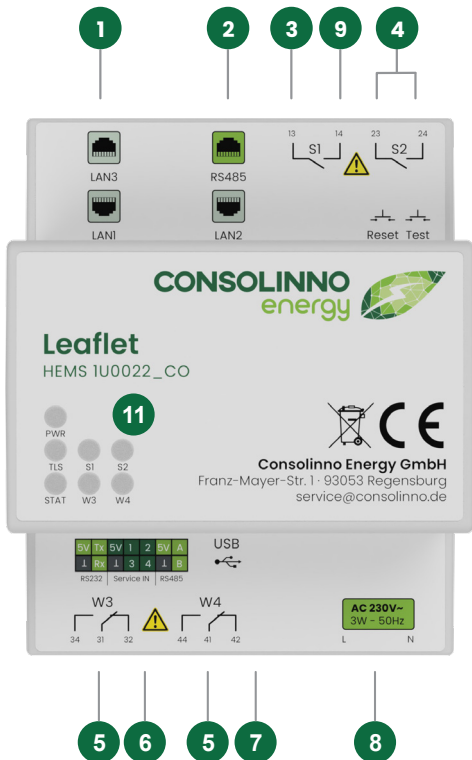

Descrizione dell'interfaccia

Nr.	Descrizione	Nr.	Descrizione
1	Ethernet 10/100 Mbit	7	Micro-USB 2.0
2	RS-485 / Ethernet 10/100 Mbit	8	Alimentazione 230 VAC 50 Hz
3	Relè 130 mA resistivo (contatto NA, LED S1/S2)	9	ZigBee (senza fili)
4	Pulsante di test / reset (senza fili)	10	Bluetooth LE (senza fili)
5	Relè 120 mA resistivo (contatto di commutazione, LED W3/W4)	11	LED di stato
6	RS-232 / Interruttori in / RS-485		

Tutte le interfacce del Leaflet HEMS di Consolinno sono isolate galvanicamente!

Pulsante

Funzione	Descrizione
Riavvio Reset	Pulsante di reset per 2 secondi -> Riavvio in corso, il LED di STATO lampeggia in verde
Reset di fabbrica	Pulsante di reset per 10 secondi -> Reset in corso, il LED di STATO lampeggia in rosso

Istruzioni di sicurezza e avvertenze



Prima della messa in funzione, leggere le istruzioni per l'installazione/istruzioni per l'uso IBA0022 su service.consolinno.de e controllare che il prodotto non sia danneggiato!

È necessario rispettare le norme di sicurezza e di prevenzione degli infortuni. Non lavorare mai in presenza di tensione. Il prodotto è un'unità da incasso e può essere installato solo in un pannello di sottodistribuzione. Il cablaggio deve essere sufficientemente dimensionato e protetto. Il prodotto non necessita di manutenzione. Le riparazioni possono essere effettuate solo dal produttore. L'apertura dell'alloggiamento comporta l'annullamento della garanzia.



PERICOLO

Pericolo di vita a causa di scosse elettriche

Scollegare il prodotto dalla rete elettrica prima di iniziare i lavori! Assicurare contro la riaccensione! Verificare l'assenza di tensione! Coprire altre parti sotto tensione!

Installation

NOTA

Il Leaflet HEMS può essere installato solo in un quadro di distribuzione o nel campo di distribuzione del quadro del contatore. Per poter utilizzare il Leaflet di Consolinno secondo le normative vigenti, è necessario un dispositivo di sezionamento dell'alimentazione. Questo deve essere adeguatamente posizionato e facilmente accessibile. Deve consentire la commutazione di almeno una fase dell'alimentazione e deve essere contrassegnato come per il Leaflet.

NOTA

Il funzionamento del dispositivo è garantito senza limitazioni nell'intervallo di $230V \pm 10\%$ della tensione di alimentazione! La fase L e il conduttore neurale N devono essere collegati all'alimentazione.



Incollare l'adesivo allegato con il numero di serie/indirizzo MAC nel pannello di sottodistribuzione, conservare gli altri adesivi in un luogo sicuro!

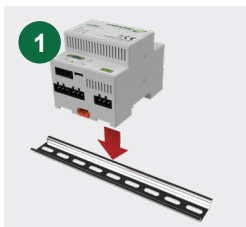

Inserire il Leaflet HEMS nella guida DIN. Si blocca da solo con l'aiuto di ganci a molla.

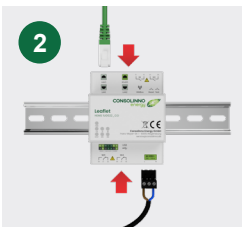

Collegare la rete a internet (LAN1), l'alimentazione e le spine necessarie, verificare la sicurezza e attivare l'alimentazione.

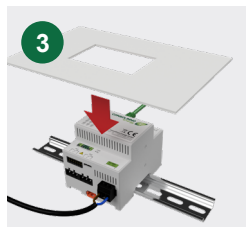

Dopo la messa in funzione tramite l'app, proteggere l'HEMS dal contatto nel campo di distribuzione del quadro del contatore con un coperchio.

Messa in funzione

Nr.	Funzione	Descrizione
1	Installare l'app	Installare l'App Consolinno Energy da Play-/App-Store
2	Connessione a internet	Connettere Leaflet LAN1 alla rete domestica (internet). Lo stato della connessione viene visualizzato tramite il LED TLS
3	Connessione alla rete domestica	Connettere lo smartphone alla rete domestica
4	Effettuare la connessione con Leaflet	Avviare l'app, selezionare Leaflet dall'elenco o selezionare "Connessione manuale" e inserire i dati di connessione (porta =2222)
5	Accesso	Inserire il nome dell'account e la password
6	Avviare la configurazione	Avviare la configurazione con la procedura guidata
7	Creare l'account del cliente finale	Una volta effettuata la messa in funzione, creare l'account per i clienti tramite (le Impostazioni di sistema -> Impostazioni utente)
8	Attivare la connessione remota	Attivare in Impostazioni di sistema -> Impostazioni di connessione (consente l'accesso al Leaflet da remoto)

Per informazioni dettagliate sulla configurazione e sul funzionamento del software HEMS, consultare le istruzioni per l'uso IBA0022.

LED

	LED	Zustand	Beschreibung
Power LED	●	permanente	attivo
		spento	spento
TLS (comunicazione)	●	permanente	connessione di rete attiva
		spento	nessuna conness. di rete
STATUS LED	●	permanente	il sistema è in esecuzione
Autenticazione / registrazione	●	lampeggia lentamente	registrazione possibile
	●	permanente	inizio delle iscrizioni
	●	3x lampeggi rapidi, poi verde	rg. avvenuta con successo
Aggiornamento	●	3x lampeggi rapidi, poi verde	registrazione errata
	●	2x lampeggi rapidi	aggiornamento disponibile
	●	3x lampeggi rapidi	l'agg. è in fase di download
Stato del servizio	●	4x lampeggi rapidi	aggiornamento in corso
	○	2x lampeggi rapidi	errore del software
	○	3x lampeggi rapidi,	ottimizzatore di errori
	○	4x lampeggi rapidi	errore OTA
S1/S2; W1/W2	●	permanente	relè attivo (chiuso)

Contenido

Datos técnicos	47
Eliminación de residuos	47
Uso previsto	48
Licencias de código abierto	48
Dimensiones	49
Puertos	50
Descripción de los puertos	51
Botones	51
Indicaciones de seguridad y advertencia	52
Instalación	52
Puesta en funcionamiento	54
LED	55

Datos técnicos

Alimentación de tensión	230 VAC 50 Hz OVCIII
Rango de temperatura de funcionamiento	-5 °C ... 55 °C
Rango de temperatura de almacenamiento	-5 °C ... 55 °C
Humedad del aire	25 % ... 70 % humedad relativa (no condensada)
Consumo máx.	3 W
Peso	225 g (sin conectores)
Clase de inflamabilidad conforme a UL94	V0
Dimensiones	4 TE (71,6 mm x 89,7 mm x 69,3 mm)
Grado de contaminación	2
Clase de protección	II (con montaje adecuado)
Altura máxima de uso	≤ 3000 m
Conformidad CE	sí

Eliminación de residuos



El dispositivo debe eliminarse como aparato electrónico conforme a la Directiva Europea 2012/19/UE y no debe eliminarse como basura doméstica. Envíe el producto de vuelta a Consolinno o elimine el aparato a través de las vías pre-

vistas. Cumpla siempre la legislación vigente en su localidad.

Uso previsto

Este producto Consolinno solo está permitido para su instalación en un cuadro de distribución o en el campo de distribución del cuadro de contadores que cumpla con las normas y disposiciones establecidas.. El producto funciona sin supervisión. Solamente se conectarán componentes verificados al producto. El mantenimiento, la instalación y la desinstalación son actividades permitidas únicamente a personal electricista. Debe garantizarse una instalación correcta. Pueden aparecer riesgos en caso de un entorno desfavorable. El producto se utilizará siguiendo exclusivamente las instrucciones de los manuales correspondientes. Por razones de seguridad, no podrán efectuarse modificaciones en el producto. Debe garantizarse una eliminación correcta.

Licencias de código abierto

El Leaflet contiene diferentes softwares con licencia, entre otros, GPLv3. Se puede acceder a un listado detallado en la red local del Leaflet a través de un navegador. También existe un enlace en la aplicación para ello:

<http://{IP-DEL-LEAFLET}:8084>

Dimensiones

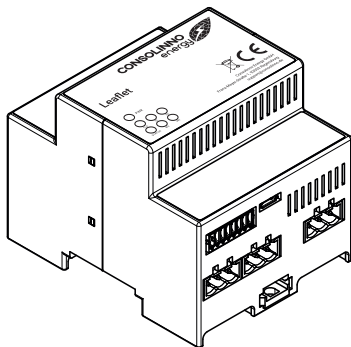
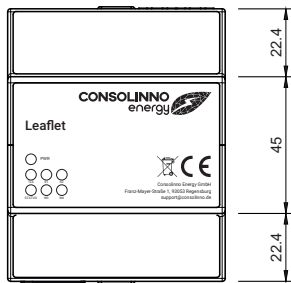
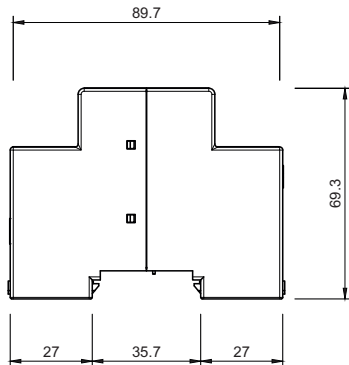
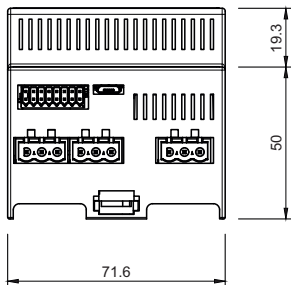

Puertos



Las presentes instrucciones de uso describen el Leaflet HEMS de Consolinno con todas sus funciones. En función de las variantes de módulos, algunas de las funciones descritas no estarán operativas.

50

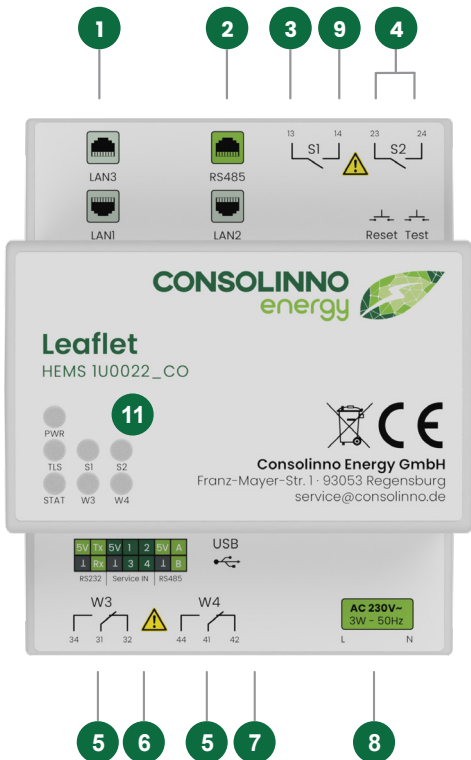

Descripción de los puertos

N.º	Descripción	N.º	Descripción
1	Ethernet de 10/100 Mbit	7	Micro USB 2.0
2	RS-485 / Ethernet de 10/100 Mbit	8	Alimentación de tensión 230 VAC 50 Hz
3	Relé 130 mA resistivo (NC, LED S1/S2)	9	ZigBee (inalámbrico)
4	Prueba / botón de reinicio (inalámbrico)	10	Bluetooth LE (inalámbrico)
5	Relé 120 mA resistivo (conmutador, LED W3/W4)	11	LED de estado
6	RS-232 / Switches en / RS-485		

Todos los puertos del Leaflet HEMS de Consolinno disponen de aislamiento galvánico.

Botones

Función	Descripción
Reinicio	Presionar botón de reinicio durante 2 s -> reinicio en marcha, el LED de estado parpadea en verde
Restaurar valores de fábrica	Presionar botón de reinicio durante 10 s -> restauración en marcha, el LED de estado parpadea en rojo

Indicaciones de seguridad y advertencia



Antes de la puesta en funcionamiento, es necesario leer el manual de instalación/las instrucciones de uso IBA0022 en service.consolinno.de y comprobar que el aparato no presente daños!

Deben cumplirse las normas de seguridad y prevención de accidentes. No trabajar nunca con la tensión activada. El aparato está previsto para integrarse en una instalación y solo puede montarse en una distribución secundaria. Dimensionar y asegurar el cableado de manera suficiente. El aparato no requiere mantenimiento. Las reparaciones solo podrán ser realizadas por el fabricante. La garantía expirará si se abre la carcasa.



PELIGRO

Peligro de muerte por descarga eléctrica

¡Desconectar la tensión antes de iniciar los trabajos!
¡Proteger contra la reconexión! ¡Garantizar la ausencia de tensión! ¡Cubrir el resto de partes activas!

Instalación

AVISO

El Leaflet HEMS solo podrá instalarse en un cuadro de distribución o en el campo de distribución del cuadro

de contadores. Para una correcta utilización del Leaflet de Consolinno se requiere un desconectador para el suministro eléctrico. Este debe estar correctamente dispuesto y tener un acceso sencillo. Debe conmutar, como mínimo, una fase del suministro y estar asignado al Leaflet.

AVISO

El funcionamiento del dispositivo está garantizado sin limitaciones en el rango de $230V \pm 10\%$ de la alimentación de tensión. Para la alimentación de tensión, el cable de fase L y el cable neutro N deben estar conectados.



Colocar el adhesivo suministrado con el número de serie/dirección MAC en la distribución secundaria y conservar el resto de los adhesivos a buen recaudo.

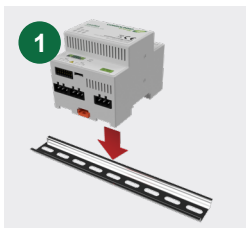

Encajar el Leaflet HEMS en el carril. Con ayuda de los ganchos de resorte, este encajará por sí mismo.

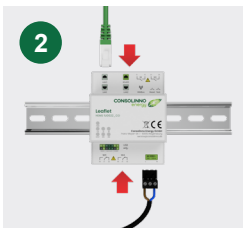

Conectar la red a Internet (LAN1), al suministro eléctrico y a los conectores necesarios, comprobar la seguridad y establecer la alimentación de tensión.

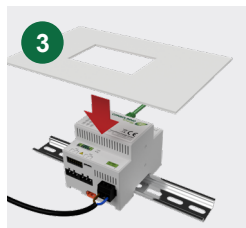

Tras la puesta en funcionamiento a través de la aplicación, proteger el HEMS con una cubierta para evitar el contacto en el cuadro de distribución.

Puesta en funcionamiento

N.º	Función	Descripción
1	Instalar la aplicación	Instalar la aplicación Consolinno Energy desde la Play-/App-Store
2	Establecer la conexión a Internet	Conectar el Leaflet LAN1 a la red doméstica (Internet). El estado de conexión se indica a través del LED TLS
3	Conectar a la red doméstica	Conectar el smartphone a la red doméstica
4	Establecer la conexión con el Leaflet	Iniciar la aplicación, seleccionar el Leaflet de la lista o seleccionar "Conexión manual" e introducir los datos de conexión (puerto = 2222)
5	Iniciar sesión	Introducir el nombre de cuenta y la contraseña.
6	Iniciar instalación	Iniciar instalación con el asistente
7	Crear cuenta de cliente	Tras la puesta en funcionamiento, crear la cuenta para el cliente (en Ajustes del sistema -> Ajustes del usuario)
8	Activar control remoto	Activar en Ajustes del sistema -> Ajustes de conexión (permite el acceso remoto al Leaflet)

Existe información más detallada sobre la configuración y el manejo del software HEMS en las instrucciones de uso 1BA0022.

LED

	LED	Zustand	Beschreibung
Power LED	●	permanente	activo
		apagado	apagado
TLS (comunicación)	●	permanente	conexión de red activa
		apagado	sin conexión de red
STATUS LED	●	permanente	sistema en funcionamiento
Autenticación / Registro	●	parpadea lentamente	es posible registrarse
	●	permanente	registro comienza
	●	3x destellos, luego verde	registro exitoso
Update	●	3x destellos, luego verde	registro defectuoso
	●	parpadea 2x rápidamente	actualización disponible
	●	parpadea 3x rápidamente	descarga de actualización
	●	parpadea 4x rápidamente	instalación de actualiz.
Estado del servicio	○	parpadea 2x rápidamente	error de software
	○	parpadea 3x rápidamente	optimizador de errores
	○	parpadea 4x rápidamente	error OTA
S1/S2; W1/W2	●	permanente	relé activo (cerrado)

